

R/A COAX PLUG+HOUSING

R197.120.F00

CABLE 2.6/50

Series : **CARLOCK**

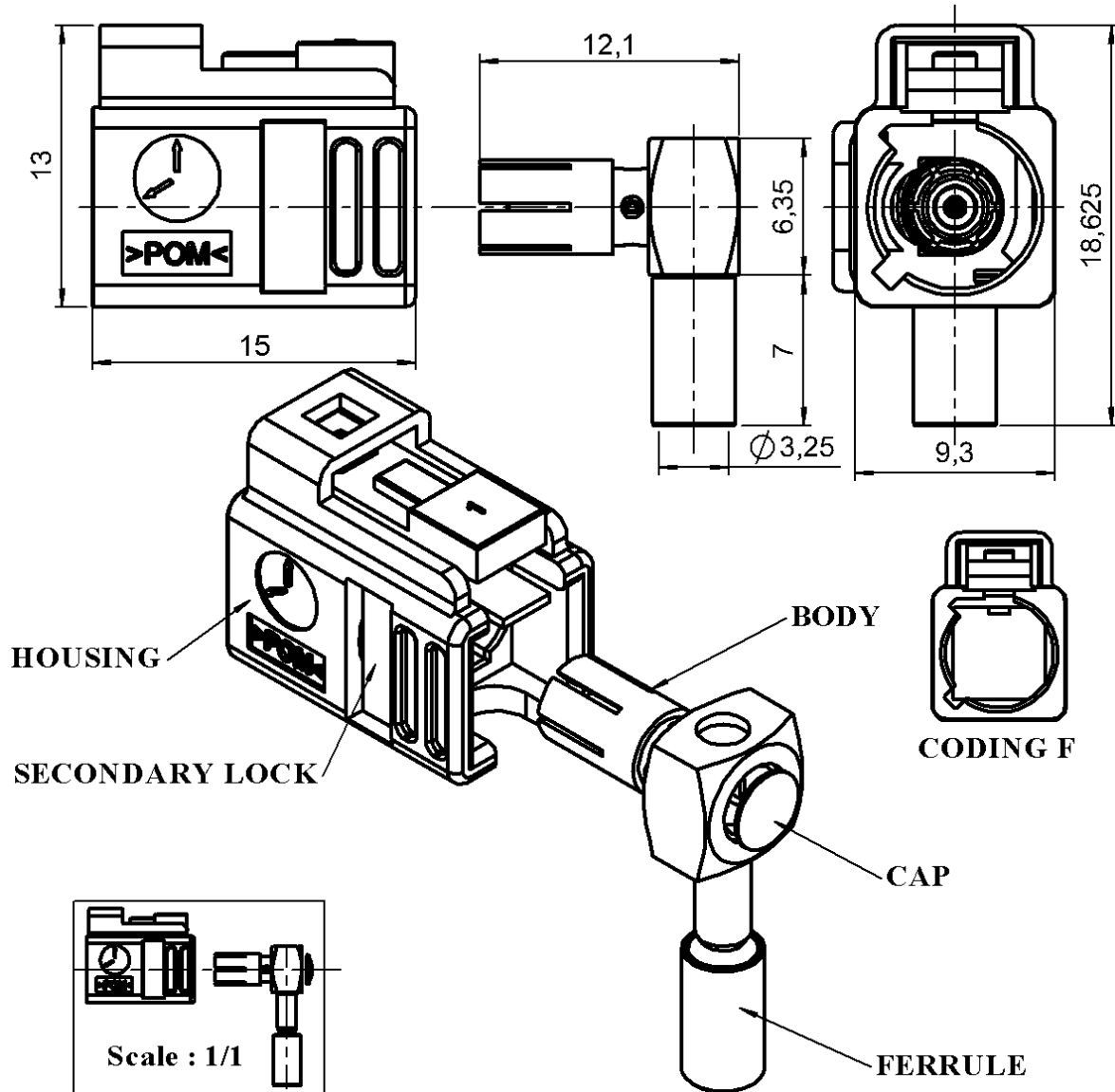

All dimensions are in mm.

COMPONENTS	MATERIALS	PLATING						
BODY CENTRE CONTACT OUTER CONTACT INSULATOR GASKET OTHERS PARTS	BRASS BRONZE BRONZE PTFE - BRASS	NICKEL 2 µm GOLD 0.8 OVER NICKEL 2 µm NICKEL 2 µm NICKEL 2 µm						
HOUSING Secondary Lock	Polyoxyméthylène (POM) Polyoxyméthylène (POM)	<table border="1"> <thead> <tr> <th>UL CLASSIFICATION</th> <th>COLOR</th> </tr> </thead> <tbody> <tr> <td>UL 94 V-2</td> <td>BROWN Ral8011</td> </tr> <tr> <td>UL 94V-2</td> <td>PURPLE RAL4006</td> </tr> </tbody> </table> <p><small>*According to FAKRA specifications</small></p>	UL CLASSIFICATION	COLOR	UL 94 V-2	BROWN Ral8011	UL 94V-2	PURPLE RAL4006
UL CLASSIFICATION	COLOR							
UL 94 V-2	BROWN Ral8011							
UL 94V-2	PURPLE RAL4006							



Issue : A0035

Design changes may be in order to improve the product.

R/A COAX PLUG+HOUSING

R197.120.F00

CABLE 2.6/50

Series : **CARLOCK**

ELECTRICAL CHARACTERISTICS

Impedance	50 Ω						
Frequency range	0-2 GHz						
	<table border="1"> <tr> <td>Frequency</td> <td>1GHz</td> <td>2GHz</td> </tr> <tr> <td>VSWR</td> <td>1.1</td> <td>1.040</td> </tr> </table>	Frequency	1GHz	2GHz	VSWR	1.1	1.040
Frequency	1GHz	2GHz					
VSWR	1.1	1.040					
Insertion loss	0.25 √F(GHz) dB						
RF leakage	- (- F(GHz)) dB mini						
Voltage rating	335 Veff Maxi						
Dielectric withstanding voltage	1000 Veff mini						
Insulation resistance	1000 MΩ mini						

SPECIFICATION

Stripping	a	b	c	d	e	f
mm	2.00	5.00	9.00	7.00	0.00	0.00

Assembly instruction : page 4

Recommended cable(s)

- RG 174
- KX 3B
- RG 188
- KX 22A
- RG 316

Cable retention

- pull off **120** N mini
- torque N.cm

MECHANICAL CHARACTERISTICS

Centre contact retention	
Axial force – Mating end	10 N mini
Axial force – Opposite end	10 N mini
Torque	N.cm mini
Recommended torque	
Mating	N.cm
Panel nut	N.cm
Clamp nut	N.cm
A/F clamp nut	0.000 mm
Mating life	100 Cycles mini
Weight	2.665 g

TOOLING

Part Number	Description	Hexagon
R282.235.003	CRIMPING DIES	M22520/5-03
R282.211.000	CRIMPING TOOL	3.25
R282.293.000	CRIMPING TOOL	M22520/5-01

OTHERS CHARACTERISTICS

Housing locking strength 80N mini
Sealing protection NA

ENVIRONMENTAL

Operating temperature	-40/+110 °C
Leakage – pressurised only	Atm.cm3/s
Hermetic seal	Mpa



Issue : **A0035**

Design changes may be in order to improve the product.

R/A COAX PLUG+HOUSING

R197.120.F00

CABLE 2.6/50

Series : **CARLOCK**

VSWR

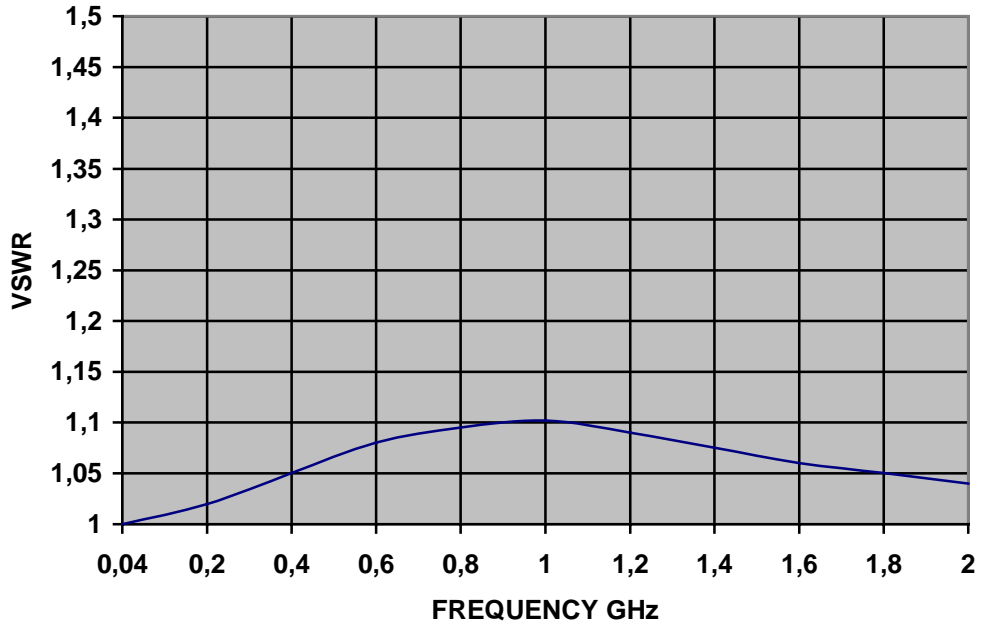

Issue : A0035

Design changes may be in order to improve the product.



R/A COAX PLUG+HOUSING

R197.120.F00

CABLE 2.6/50

Series : **CARLOCK**

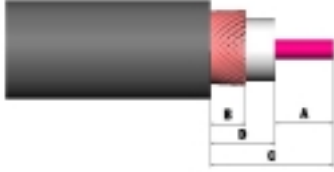
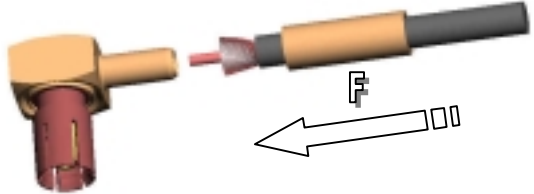
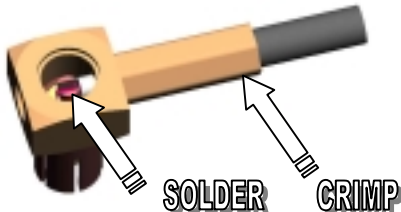
RECOMMENDED MOUNTING PROCEDURE

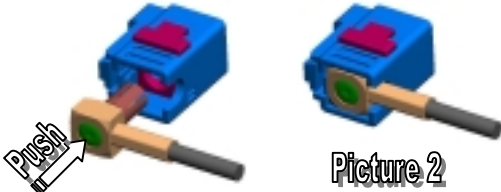
<p>1</p> <ul style="list-style-type: none"> • Slide onto the cable the ferrule • Strip the cable 	
<p>2</p> <ul style="list-style-type: none"> • Fan the braid • Push connector body under the braid • Slide the ferrule on the braid (in direction F) 	
<p>3</p> <ul style="list-style-type: none"> • Crimp the ferrule with crimping tool R282.211.000 (Hex:3.25) or crimping tool R282.293.000 (M22520/5-01) + dies R282.235.003 (M22520/5-03) • Solder inner conductor 	
<p>4</p> <ul style="list-style-type: none"> • Place the cap • Press cap flush or slightly below surface of body assembly 	
<p>5</p> <ul style="list-style-type: none"> • Push the coax in the housing till it snap on (according to picture 2) 	
<p>6</p> <ul style="list-style-type: none"> • To secure the coax inside the housing , push the secondary lock in final position (until it click on) 	